

ITEM NO.	PART NUMBER	DESCRIPTION	QTY.
1	104-RO-09-09	Tile-Over Tray 900 x 900 Rear Outlet (4 Sided)	1

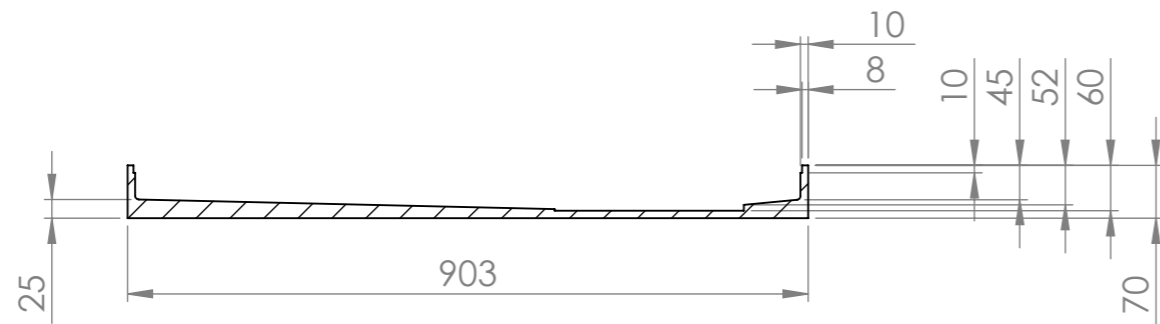

SECTION A-A
CROSS SECTION VIEW

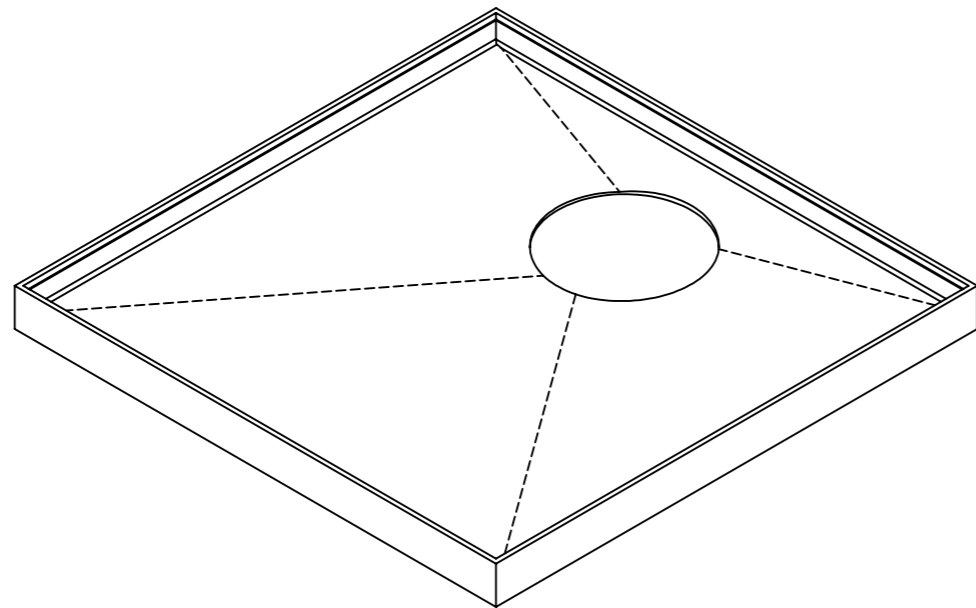

ISOMETRIC VIEW

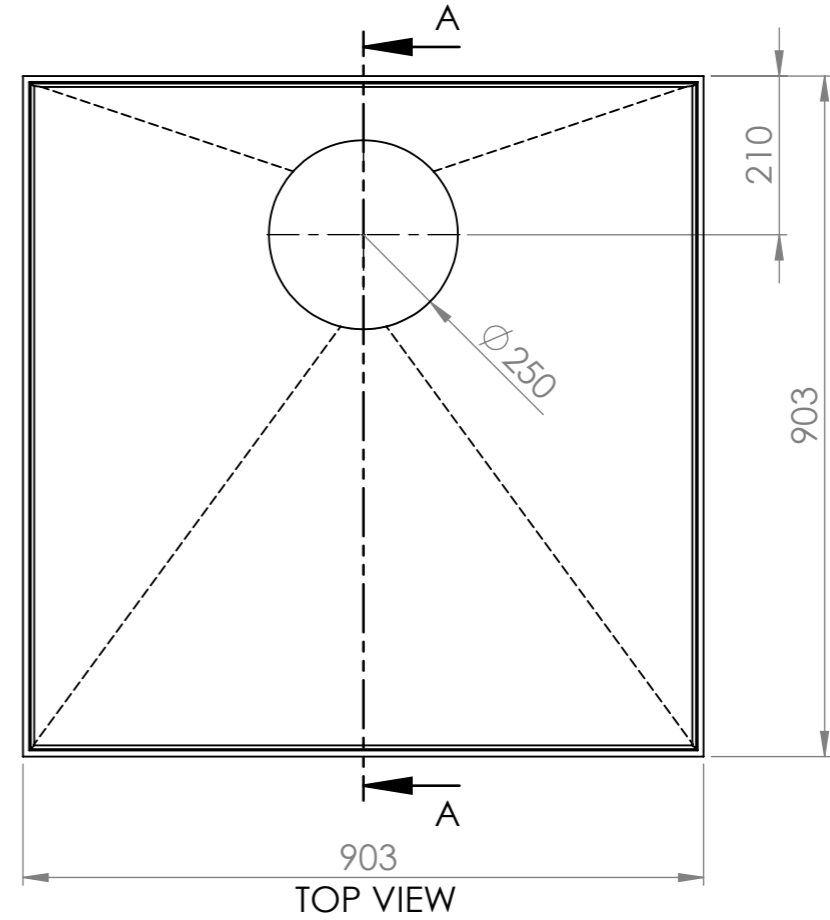

TOP VIEW

 Wet Area Solutions (Aust) Pty Ltd 5 Kim Court North Geelong VIC 3215 Phone: (03) 9034 1011 Email: sales@wetareas.com.au Website: www.wetareas.com.au	Material: High Density Polyurethane	DO NOT SCALE DRAWING	REVISION 1.4	
	Part Number: 104-RO-09-09	TITLE: Tile-Over Tray 900 x 900 Rear Outlet (4 Sided)		
	UNLESS OTHERWISE SPECIFIED: DIMENSIONS ARE IN MILLIMETERS SURFACE FINISH: TOLERANCES: 5mm ALL FILLETS 2mm UNLESS SPECIFIED	SIZE A3	DWG NO. 7 of 15	SCALE: 1:10 PAGE: 7
	Draw and prepared by NAME SIGNATURE DATE Jason Duong	This drawing and design belongs to Wet Areas Patent (prov.) 2012904805		